

# PC410 ○

## Compact, Surface Mount Ultra-high Speed Response OPIC Photocoupler

### ■ Features

1. Opaque, mini-flat package
2. Ultra-high speed response  
( $t_{PLH}, t_{PHL}$  : TYP. 50ns at  $R_L=350\Omega$ )
3. Isolation voltage between input and output  
( $V_{iso}$  : 2500  $V_{rms}$ )
4. Instantaneous common mode rejection  
voltage  $CM_H$  : TYP. 500V/ $\mu s$
5. Recognized by UL, file N0.64380

### ■ Applications

1. Hybrid substrate which requires high density mounting
2. Personal computers, office computers and peripheral equipment
3. Electronic musical instruments
4. Audio equipment

### ■ Outline Dimensions

(Unit : mm)

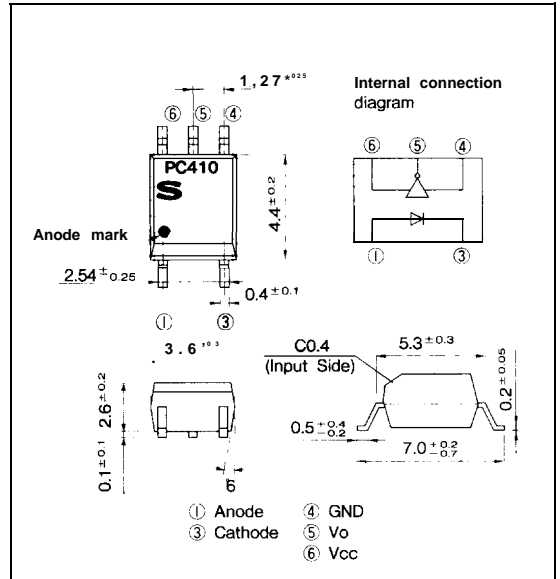

### ■ Package Specifications

Model No.	Package specifications	anometer of ree	Tape width
PC410	Taping package(Net:3 600 pcs.)	$\phi 370$ mm	12mm
PC410T	Taping package(Net:750 pcs.)	4178mm	12mm
PC41 Oz	Sleeve package( Net: 10 0 pcs.)		

### ■ Absolute Maximum Ratings

( $T_a = 25^\circ C$ )

Parameter		Symbol	Rating	Unit
Input	*1 Forward current	$I_F$	20	mA
	Reverse voltage	$V_R$	5	V
	Power dissipation	P	40	mW
output	*2 Supply voltage	$V_{CC}$	7	V
	High level output voltage	$V_{OH}$	7	V
	Low level output current	$I_{OL}$	50	mA
	Output collector power dissipation	$P_O$	85	mW
*3 Isolation voltage		$V_{iso}$	2500	$V_{rms}$
Operating temperature		$T_{opr}$	0 to +70	$^\circ C$
Storage temperature		$T_{stg}$	-40 to +125	$^\circ C$
*4 Soldering temperature		$T_{sol}$	260	$^\circ C$

\*1  $T_a = 0$  to  $+70^\circ C$

\*2 For 1 minute MAX,

\*3 AC for 1 minute, 40 to 60%RH. Apply the specified voltage between the whole of the electrode pins on the input side and the whole of the electrode pins on the output side.

\*4 For 10 seconds.

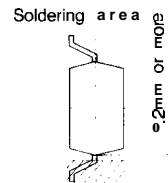

## ■ Electro-optical Characteristics

(Ta = 0 to +70°C unless otherwise specified)

Parameter		Symbol	Conditions	MIN.	TYP.	MAX.	Unit		
Input	Forward voltage	$V_F$	Ta = 25°C, $I_F = 10\text{mA}$	—	1.6	1.9	V		
	Reverse current	$I_R$	Ta = 25°C, $V_R = 5\text{V}$	—	—	10	$\mu\text{A}$		
	Terminal capacitance	$C_t$	Ta = 25°C, V=O, f=1MHz	—	60	150	pF		
output	Low level output voltage	$V_{OL}$	$I_{OL} = 13\text{mA}$ , $V_{CC} = 5.5\text{V}$ , $I_F = 5\text{mA}$	—	—	0.6	v		
	High level output current	$I_{OH}$	$V_{CC} = V_O = 5.5\text{V}$ , $I_F = 250/\mu\text{A}$	—	2	250	$\mu\text{A}$		
	Low level supply current	$I_{CCL}$	$V_{CC} = 5.5\text{V}$ , $I_F = 10\text{mA}$	—	13	18	mA		
	High level supply current	$I_{CCH}$	$V_{CC} = 5.5\text{V}$ , $I_F = 0$	—	7	15	mA		
	"H→L" threshold input current	$I_{FHL}$	$V_{CC} = 5\text{V}$ , $V_O = 0.8\text{V}$ , $R_L = 350\Omega$	—	2.5	5	mA		
Isolation resistance		$R_{ISO}$	Ta = 25°C, DC500V, 40 to 60% RH	$5 \times 10^{10}$	$10^{11}$	—	$\Omega$		
Floating capacitance		$C_f$	Ta = 25°C, V=O, f=1MHz	—	0.6	5	DF		
Transfer characteristics	response time	"H→L" propagation delay time	$t_{PHL}$	Ta = 25°C	—	50	120	ns	
		"L→H" propagation delay time	$t_{PLH}$	$V_{CC} = 5\text{V}$ , $I_F = 7.5\text{mA}$ $R_L = 350\Omega$ , $C_L = 15\text{pF}$	—	50	120		
		Fall time	$t_f$	Fig. 1	—	30	60		
		Rise time	$t_r$	Fig. 1	—	30	fin		
	CMR	Instantaneous common mode rejection voltage "High level output"	CMH	$I_F = 0$ $V_O(\text{MIN.}) = 2\text{V}$	Ta = 25°C $V_{CC} = 5\text{V}$ $V_{CM} = 10\text{V(Peak)}$	100	500	—	V/ $\mu\text{s}$
		Instantaneous common mode rejection voltage "Low level"	CM <sub>L</sub>	$I_F = 5\text{mA}$ $V_O(\text{MAX.}) = 0.8\text{V}$	$R_L = 350\Omega$ Fig. 2	= 100	= 500	—	

Note) All typical values : at Ta = 25-C, V<sub>CC</sub> = 5V

Each characteristics shall be measured under opaque condition.

## ■ Recommended Operation Conditions

Parameter	Symbol	MIN.	MAX.	Unit
Low level input current	$I_{FL}$	0	250	$\mu\text{A}$
High level input current	$I_{FH}$	7	15	mA
Supply voltage	$V_{CC}$	4.5	5.5	V
Fanout (TTL load)	N	—	8	—
Operating temperature	$T_{opr}$	0	70	°C

Connect a by-pass ceramic capacitor (0.01 to 0.1  $\mu\text{F}$ ) between V<sub>CC</sub> and GND at the position within 1cm from lead pin.

Fig. 1 Test Circuit for  $t_{PHL}$ ,  $t_{PLH}$ ,  $t_r$  and  $t_f$

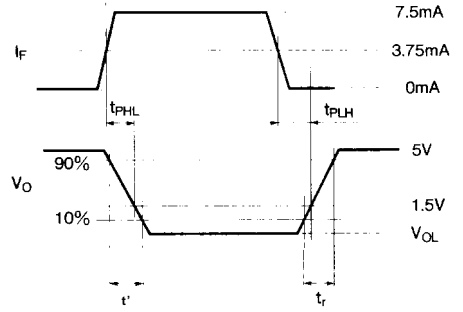
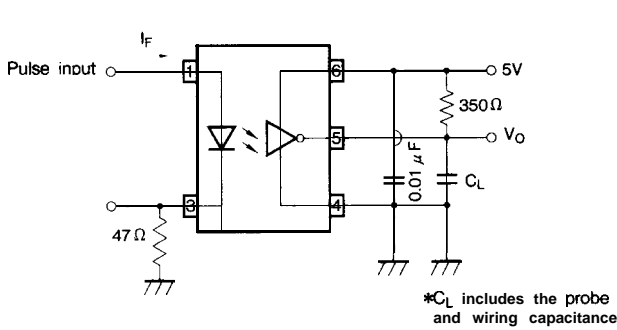

Fig. 2 Test Circuit for Instantaneous Common Mode Rejection Voltage

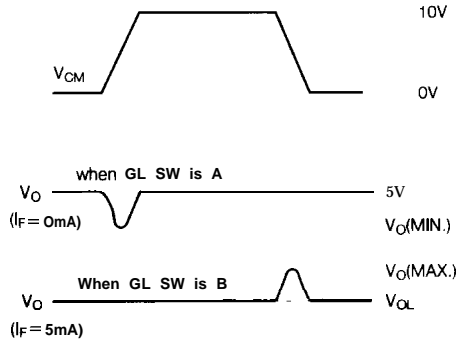
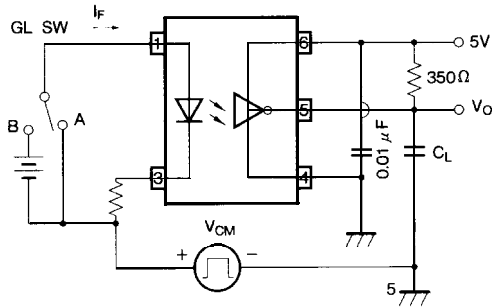

Fig. 3 Collector Power Dissipation vs. Ambient Temperature

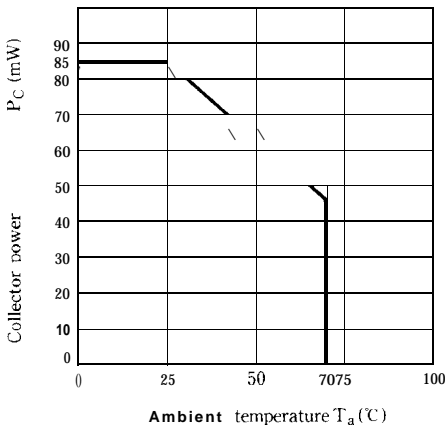
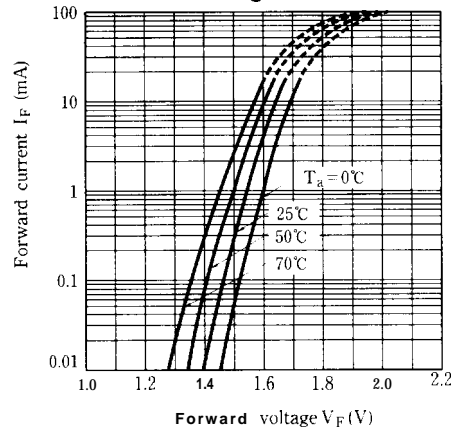
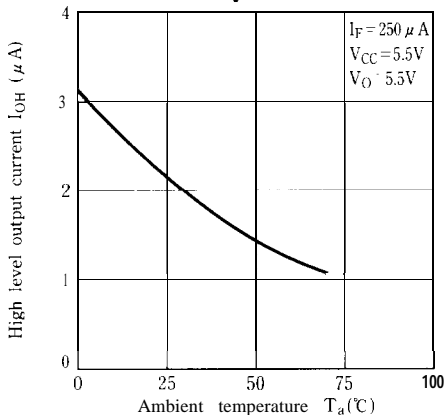

Fig. 4 Forward Current vs. Forward Voltage



**Fig. 5 High Level Output Current vs. Ambient Temperature**



**Fig. 6 Low Level Output Voltage vs. Ambient Temperature**

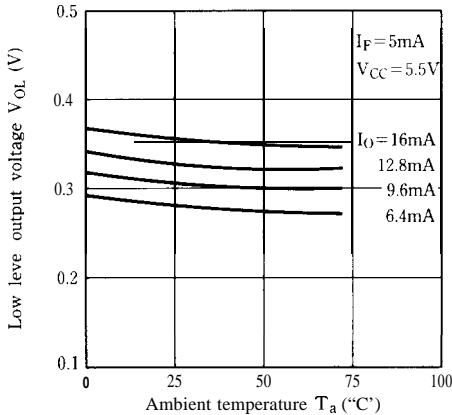

**Fig. 7-a Output Voltage vs. Forward Current**

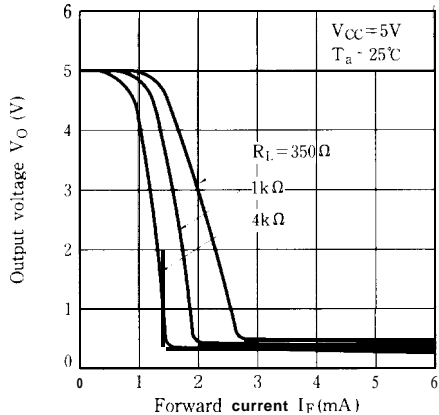

**Fig. 7-b Output Voltage vs. Forward Current (Ambient Temp. Characteristics)**

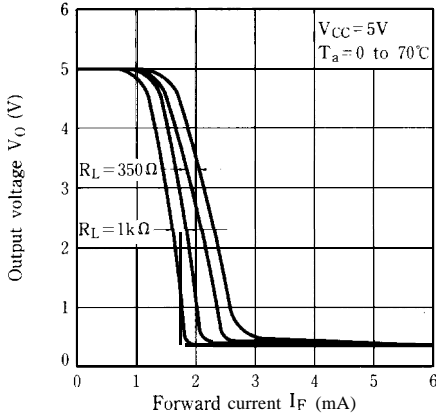

**Fig. 8 Propagation Delay Time vs. Forward Current**

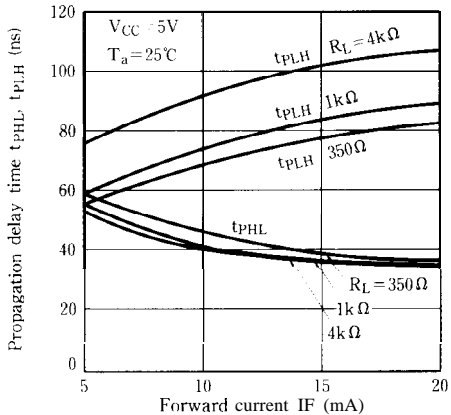

**Fig. 9 Propagation Delay Time vs. Ambient Temperature**

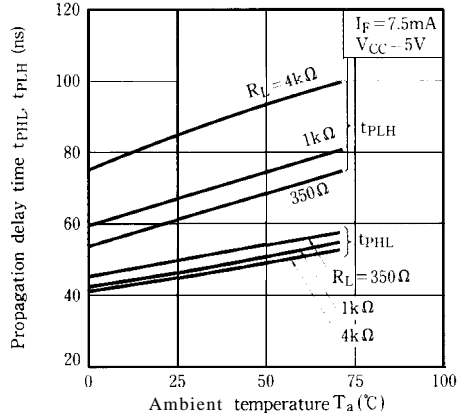

**Fig.10 Rise Time, Fall Time vs. Ambient Temperature**

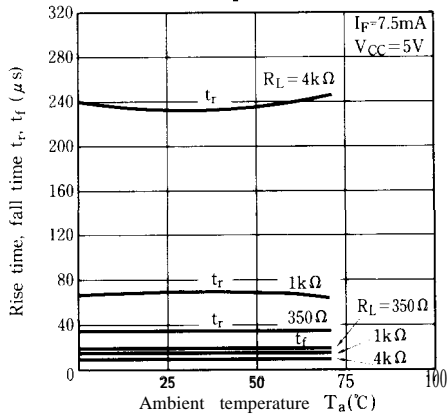

### ■ Precautions for Use

- (1) Handle this product the same as with other integrated circuits against static electricity.
- (2) As for other general cautions, refer to the chapter "Precautions for Use." (Page 78 to 93).